

American Journal of Computing and Engineering (AJCE)

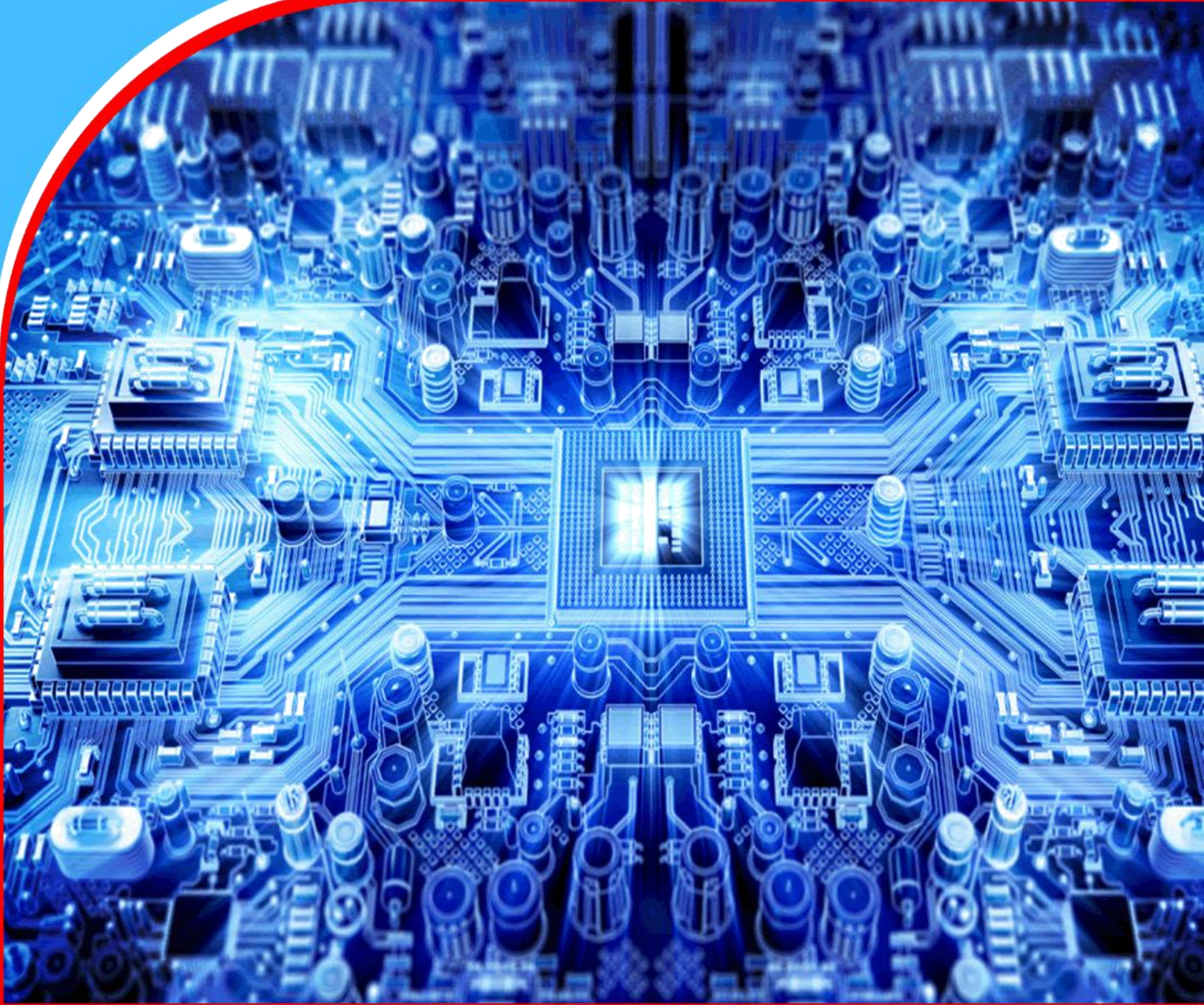

Design of a frequency reconfigurable rectangular patch antenna for 2.4 GHz Wi-Fi application.

*Alain François Kuate, Paulin Nembot Tchueguem, and
Jean-François D. Essiben*



Design of a frequency reconfigurable rectangular patch antenna for 2.4 GHz Wi-Fi application

Alain François Kuate¹, Paulin Nembot Tchueguem², and Jean-François D. Essiben³

^{1,3} Department of Electrical Engineering, Advanced Teachers, Training College for Technical Education, Laboratory of Technologies and Applied Sciences (LTSA), University of Douala, B.P. 1872, Douala, Cameroon

² Department of Electrical Engineering, Laboratory of Automation and Applied Informatics (LAIA), B.P. 134 Bandjoun, Cameroon

Corresponding Author's Email: kuatealainfrancois@yahoo.fr

Abstract

Purpose: This paper presents the design and analysis of rectangular patch antenna that can be reconfigured in frequency for the three non-overlapping channels of the 2.4 GHz Wi-Fi.

Methodology: To achieve this, a patch model in which four Pin diodes are introduced into the radiating structure, two operating in switching (ON / OFF) and two others kept blocked throughout operation has been proposed. By using as radiating element a copper hob placed on a substrate of the FR4_Epoxy type. The so-called CST Microwave Studio simulation software was used to simulate the design antenna.

Findings: It was shown that this rectangular patch antenna resonates at the center frequencies of channels 1 (2.412GHz); 6 (2.437 GHz) and 11 (2.462 GH) with an almost uniform radiation pattern for different diode configurations.

Recommendations: To improve the performance of this reconfigurable frequency patch antenna, future research must be based on optimizing the radiation parameters for configurations where one of the diodes is ON and the other is blocked.

Keywords: *Patch antenna, reconfigurable antenna, reflection coefficient, radiation pattern.*

1. Introduction

Wireless communications, mainly using electromagnetics, are omnipresent in our daily life (radio, television, mobile telephony, Wi-Fi, Bluetooth, etc...) and have become essential for the majority of inhabitants of industrialized and non-industrialized countries, both for their professional and private life. This results in a significant presence of electromagnetic waves transmitters in our environment. The availability of this ambient energy may be of interest for certain low-consumption applications whose frequency bands are mostly used by mobile phone frequencies (900 MHz; 1.8 GHz; 2.1 GHz and 2.6 GHz), Wi-Fi (2.4-2.485 GHz) and Wi-Fi governed by the 802.11b standard [1].

The 2.400-2.4835 GHz frequency band of 2.4 GHz Wi-Fi is divided into 14 channels of 22 MHz bandwidth [2]. The centers of the said channels are only spaced 5 MHz apart so that they partially overlap and that only channels 1, 6 and 11 are sufficiently spaced and can be used simultaneously by networks in order to have optimum performance. If two networks use channels with overlapping frequencies, one will detect that the other's signals are interference [3] and vice versa. In addition to the overlaps between channels, the 2.4 GHz Wi-Fi band is sensible to interference from other networks such as Bluetooth which operates in the same frequency band as 2.4 GHz Wi-Fi and to disruptors linked to the transmission channel in free space. However, it is important to underline that it is the antenna [4,5] which must ensure the best transmission between the terminals, it is also this which conditions the coexistence of the systems by radiating selectively in space in order to protect the other systems from interference (jamming). Antennas which can be reconfigured in terms of frequencies [6], radiation patterns [7] and polarization [8] constitute a promising research theme in various fields of wireless telecommunications. It is in this direction that we plan to develop a research activity which mainly aims at the design and realization of new antenna topologies that can be used as a basic element for 2.4 GHz Wi-Fi, the coverage of which requires 14 channels use of 85 MHz wideband antenna. In the literature [9,10], there is a wide variety of types of broadband antennas [11] for 2.4GHz Wi-Fi systems, a major disadvantage is their sensitivity to interference from channels whose frequencies overlap and to networks operating at the same working frequency. A solution making it possible to remedy the shortcomings of covering, by electronic control, each of the channels available in the 2.4 GHz Wi-Fi. This makes use of frequency reconfigurable antennas first introduced in 1998 [12,13].

The antenna reconfigurability technique increases the functionalities of a conventional antenna by offering it the ability to change one or more of its fundamental characteristics by electrical, mechanical or other means, and this according to the needs and the environmental context [14,15]. The reconfiguration of the antennas is carried out by modifying the distribution of the electric current, consequently the properties of the electromagnetic field and of the impedance, therefore the transmission and reception properties, and this in a discrete or continuous manner. Printed antennas are widely used for this reconfigurability function [16,17]. This is due to their low weight, low manufacturing cost and above all the ease of integration of the microwave components within them. Frequency agility is obtained by modifying the electrical length of the radiating element. For this, the antenna is charged by active elements whose impedance can be controlled electronically, or by components playing the role of switch [18].

In this paper, a frequency reconfiguration method for the design of a patch antenna on an FR4 epoxy substrate, dedicated to a 2.4 GHz Wi-Fi application has been proposed. The proposed method consists of inserting Pin diodes within the radiating structure in order to obtain, according to their states (ON, OFF), an antenna covering channels 1, 6 and 11 of the 2.4 GHz

Wi-Fi. The simulation of the said antenna, the output parameters of which are the coefficient of reflection and radiation pattern, was carried out using the simulation software CST (Computer Simulation Tool) Microwave Studio.

2. Antenna design

2.1. Geometry of the structure

The patch antenna designed (figure 1) and intended to operate at a frequency of 2.4GHz, is a rectangular patch printed on the upper face of a dielectric substrate of the FR4 epoxy type of relative permittivity 4.3 and of thickness 1.6, the face of which bottom is completely metallized (plan of mass). Four MP4203 Pin diodes (D1, D2 and D) are each inserted into one of the four slots created at a distance d_0 at each top edge of the radiating structure. Only diodes D1 and D2 operate in commutation in an ON/OFF configuration while diodes D remain blocked (OFF). The figure 1 shows the geometric structure of the proposed antenna.

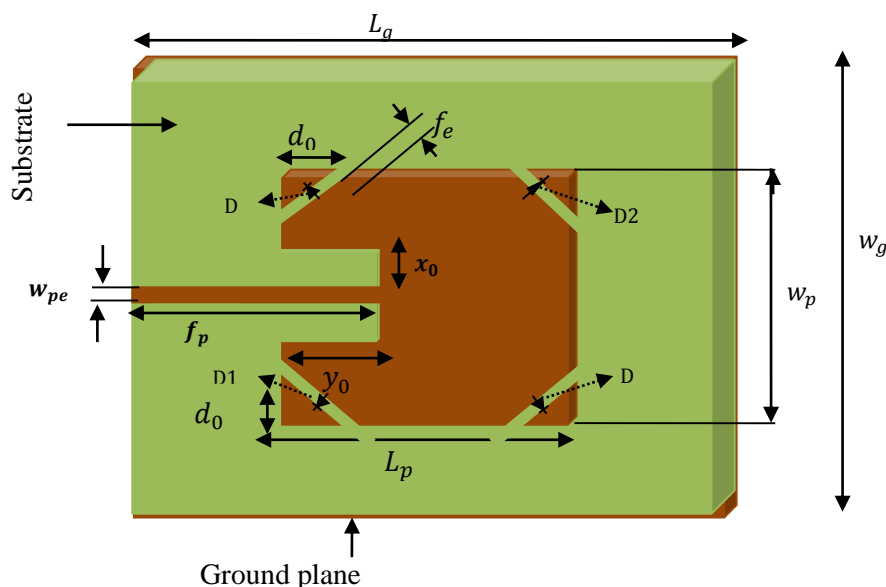

Figure 1: Geometry of the patch reconfigurable

2.2. Design of the reconfigurable patch antenna

The design of the rectangular and frequency reconfigurable patch antenna operating in the frequency band between 2.4 and 2.485 GHz is carried out in three stages:

- The design of the patch whose calculations of geometric parameters are those based on the model of transmission lines [19,20] and formulas Schneider [21] and Hammerstad [22]. a notch-type impedance matching was adopted for [19].
- The creation of a slot of width f_e [23,24] at a distance d_0 of the upper edges of the radiating structure.
- The insertion in the middle of each slot of an MP4203 [25] Pin diode whose equivalent model (figure 2) is a series inductor $L = 0.45nH$ with a resistor $R_S = 35\Omega$ in the ON configuration and a series inductor $L = 0.45nH$ with a parallel circuit consisting of a capacitor $C_T = 0.08nF$ and resistor $R_p = 3K\Omega$ in the OFF configuration. Frequency reconfigurability consists of making the antenna designed resonate at the central

frequencies of the Wi-Fi channels (table 1) according to the ON/OFF states of the diodes

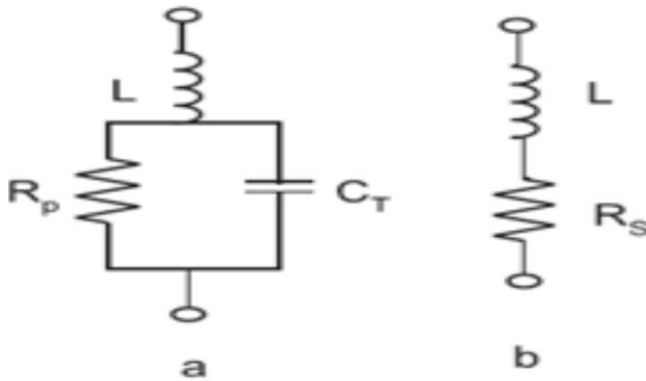

Figure 2: Equivalent Model of Pin diode

(a) Model OFF: (b) Model ON

Table 1 : 2.4 GHz Wi-Fi Channel distribution [2]

Channel	Center frequency	Canal	Center frequency
1	2.412	8	2.447
2	2.417	9	2.452
3	2.422	10	2.457
4	2.427	11	2.462
5	2.432	12	2.467
6	2.437	13	2.472
7	2.442	14	2.484

The geometrical and radioelectric data of the reconfiguration patch antenna are presented in table 2.

Table 2 : geometrical and radioelectric data of the reconfigurable patch antenna in mm

Length patch L_p	28.902
Width patch w_p	38
Feed line length f_p	23.39
Feed line width w_{pe}	3.137
Notch length y_0	8.85
Notch width x_0	1
Mass plane length L_g	58
Mass plane width w_g	76
Slot width f_e	1
Distance from top edges of patch d_0	6.9

2.3. Parameters of antenna

The expressions of the radiation pattern, of gain and the coefficient of reflection of the rectangular traversed by a sinusoidal current of amplitude I_0 are the following:

Radiation pattern of the antenna; $U(\theta, \varphi) = |E_\theta / E_{\theta_{\max}}|$

where $E_\theta = -jk \frac{e^{-jkr}}{4\pi r} 4I_0 w_p \sin c(k \frac{w_p}{2} \sin \varphi \sin \theta) \cdot \cos(k \frac{L_p}{2} \cos \varphi \sin \theta) \cos \varphi$ is the electric field and $E_{\theta_{\max}}$ its maximum value, j is a complex number, $k = 2\pi / \lambda$ is the number of wave, λ is the wavelength, r is the distance between the center of the system and the point of observation in direction (θ, φ) , θ is the elevation, φ is the azimuth,

Coefficient of reflection of the antenna: $\Gamma_{in} = (Z_{in} - Z_0) / (Z_{in} + Z_0)$

where $Z_{in} = R_{in} + jX_{in}$ is the impedance of an entry of the antenna and constitutes of an active and reactive part; $Z_0 = 50\Omega$

3. Results and discussion

This section presents the simulation results of the proposed frequency reconfigurable patch antenna. The parameters evaluated are the coefficient of reflection and the radiation pattern according to the ON/OFF state of the diodes D1 and D2. The coefficient of reflection will make it possible to evaluate the frequency tunability [26] and adaptability [27] of the designed antenna.

3.1. Coefficient of reflection

Figure 3 presents the coefficient of reflection in entry of the frequency reconfigurable patch antenna in configuration where diodes D1 and D2 are all OFF. Taking into consideration this figure, it resounds to 2.4132 GHz, corresponding to the center frequency of Wi-Fi 2.4 GHz channel 1. This coefficient of reflection is -19.94058 dB and shows that this antenna is adapted to the frequency of 2.4132 GHz.

Figure 4 presents the coefficient of reflection in entry of the frequency reconfigurable patch antenna in configuration where diodes D1 OFF and D2 ON. Taking into consideration this figure, it resounds to 2.4372 GHz, corresponding to the center frequency of Wi-Fi 2,4 GHz channel 6. This coefficient of reflection is -16.0364dB and shows that this antenna is adapted to the frequency of 2.4372 GHz.

Figure 5 presents the coefficient of reflection in entry of the frequency reconfigurable patch antenna in configuration where diodes D1 ON and D2 OFF. Taking into consideration this figure, it resounds to 2.4624 GHz, corresponding to the center frequency of Wi-Fi 2,4 GHz channel 11. This coefficient of reflection is -16.0364dB and shows that this antenna is adapted to the frequency of 2.4624 GHz.

Figure 6 summarizes the variation curves of the coefficient of reflection of antenna designed for different configurations of the Pin diodes. It is noted that:

- A better frequency tenability [28] of 2.03% proof that, for different configuration of the Pin diodes, the antenna resounds almost at the center frequency of channels 1, 2 and 6;
- Each $S_{11} \leq -10dB$ proof that the designed antenna is perfectly adapted for millimeter wave communication devices [29].

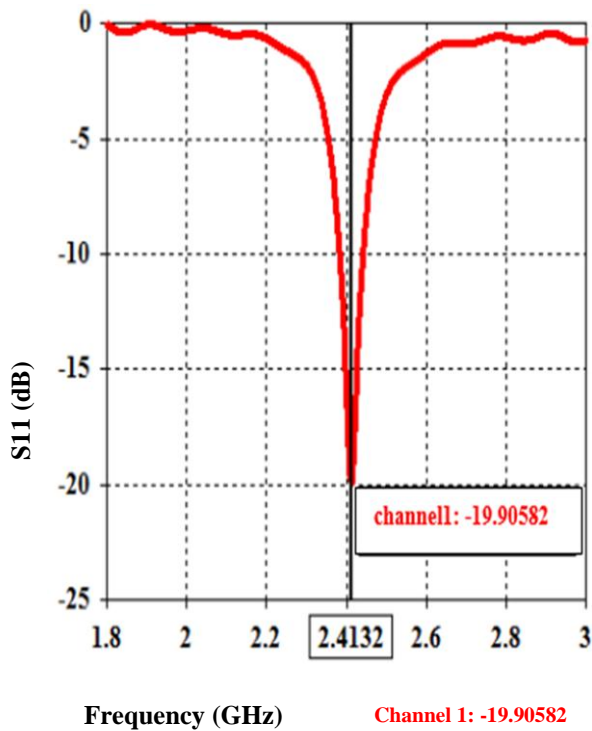

Figure 3: Coefficient of reflection (channel 1) D1 and D2 OFF

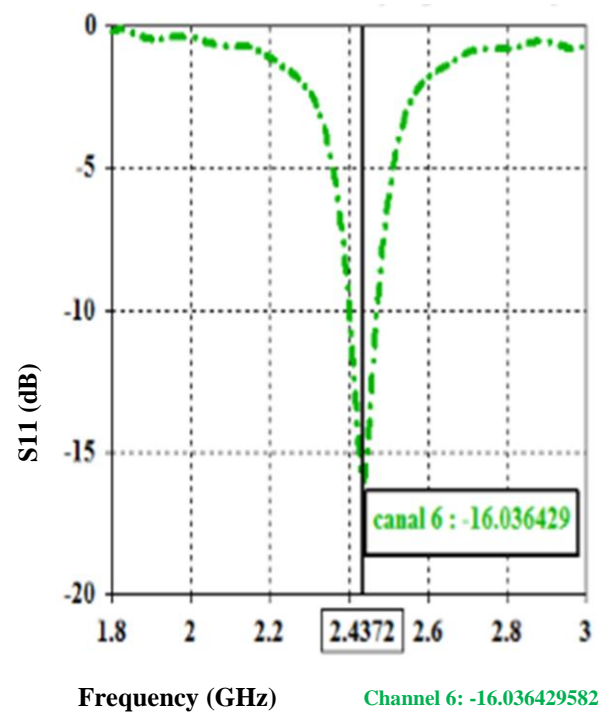

Figure 4: Coefficient of reflection (canal 6) D1 OFF and D2 ON

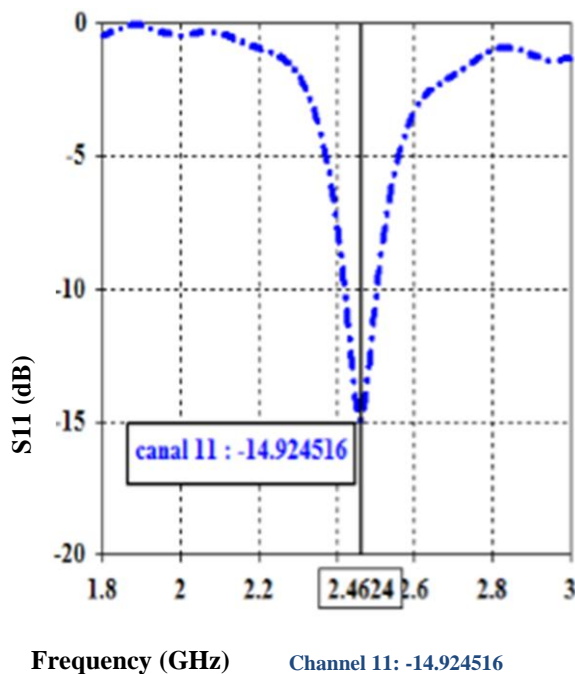

Figure 5: Coefficient of reflection (canal 6) D1 ON and D2 OFF

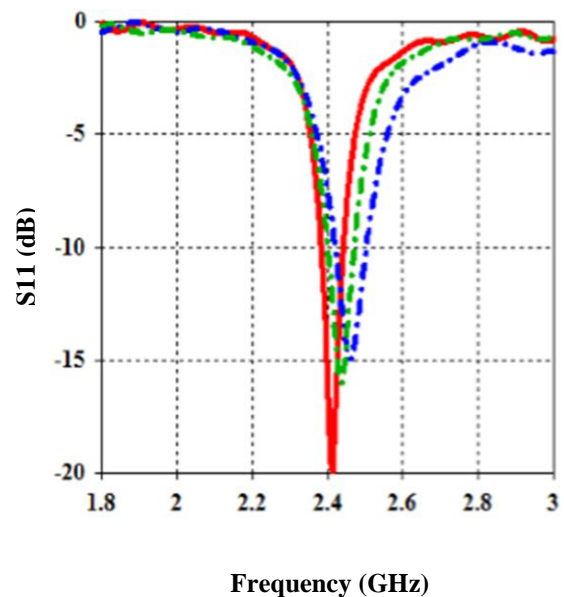

Figure 6: Coefficient of reflection for different configurations of the Pin diodes.

D1 and D2 all OFF in **red** (channel 1), D1 OFF and D2 ON in **green** (channel 6), D1 ON and D2 OFF in **blue** (channel 11)

3.2. Radiation pattern

Figure 7 presents the radiation patterns of antenna in polar co-ordinates in the vertical plane ($\varphi = 90^\circ$) where the diode D1 and D2 are all OFF. A gain of 4.12 dB in the main lobe direction at 0.0° and for a maximum side lobe level equal to -12.6 dB are obtained. The analysis of these numerical results has shown that with this configuration of the diodes, this antenna is indeed intended for Wi-Fi applications

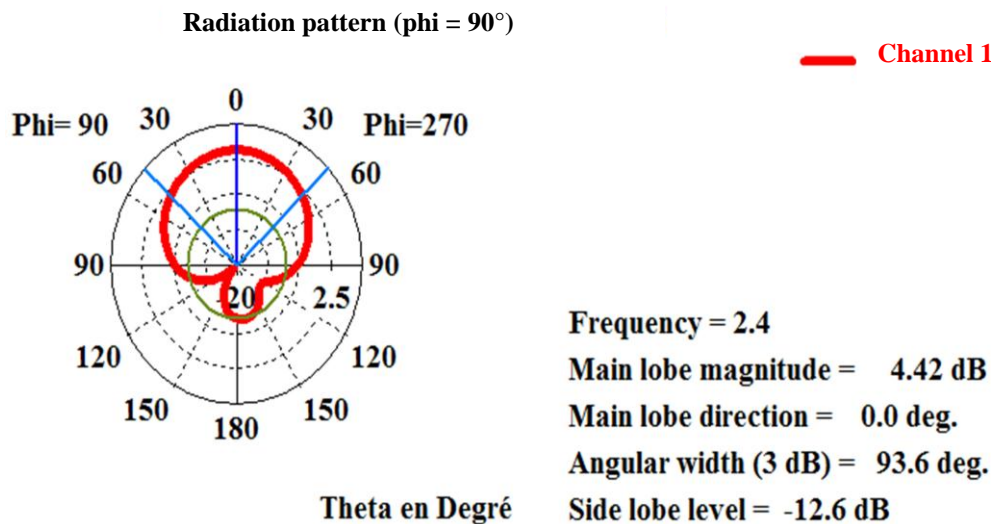

Figure 7: Radiation pattern (*channel 1*) D1 and D2 all OFF

Figure 8 presents the radiation patterns of antenna in polar co-ordinates in the vertical plane ($\varphi = 90^\circ$) where D1 OFF and D2 ON. We obtain a gain of 2.24 dB in the main lobe direction at 0.0° , for a maximum level of secondary lobes equal to -12.6 dB. The analysis of these numerical results has shown that with this configuration of the diodes, this antenna is indeed intended for Wi-Fi applications.

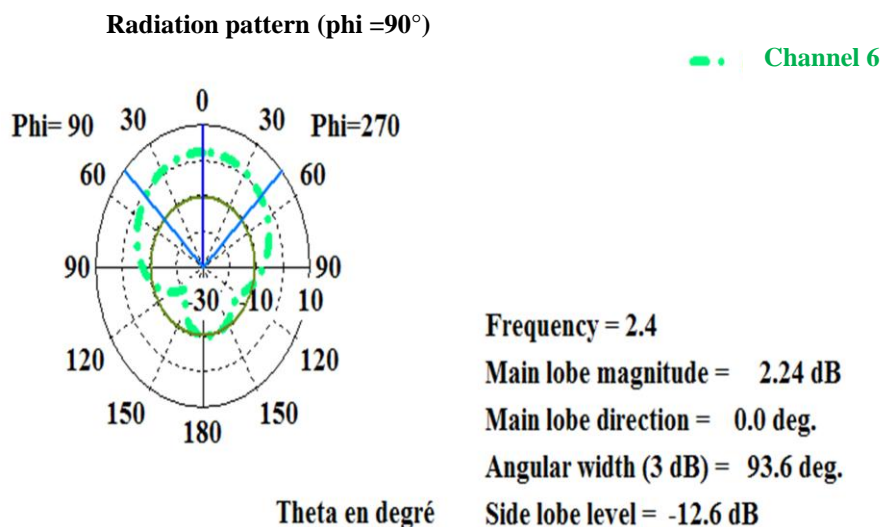

Figure 8: Radiation pattern (*channel 6*) D1 OFF and D2 ON

Figure 9 presents the radiation patterns of antenna in polar co-ordinates in the vertical plane ($\phi = 90^\circ$) where D1 OFF and D2 ON. We obtain a gain of 1.7 dB in the main lobe direction at 0.0° , for a maximum level of secondary lobes equal to -12.6 dB. The analysis of these numerical results has shown that with this configuration of the diodes, this antenna is indeed intended for Wi-Fi applications.

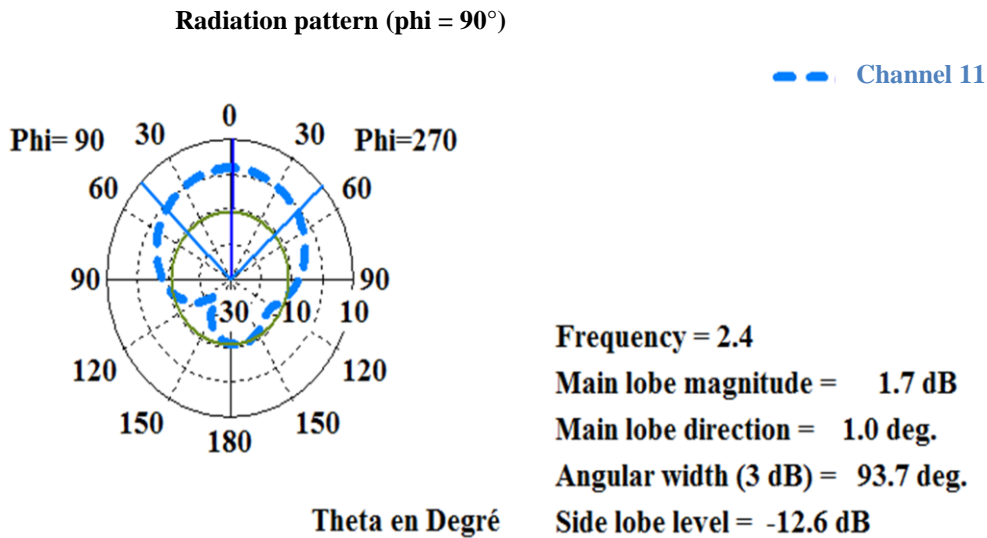

Figure 9: Radiation pattern (*channel 11*) D1 ON and D2 OFF

Figure 10 compares the radiation patterns of antenna in polar co-ordinates in the vertical planes ($\phi = 90^\circ$). We note that the different diagrams obtained have exactly the same shape for different configurations of diodes D1 and D2. The comparative data of the electrical and radiation (gain) characteristics for different Pin diode configurations are summarized in table 3. The analysis of the numerical results has shown that the radiation patterns have exactly the same shape for different Pin diode configurations. This justifies that our antenna cannot reconfigured in radiation pattern but in frequency. However, we note a relatively low gain if one diode is ON the other is blocked. This is due to the position of ON diode (inductive load) in relation to the feed line.

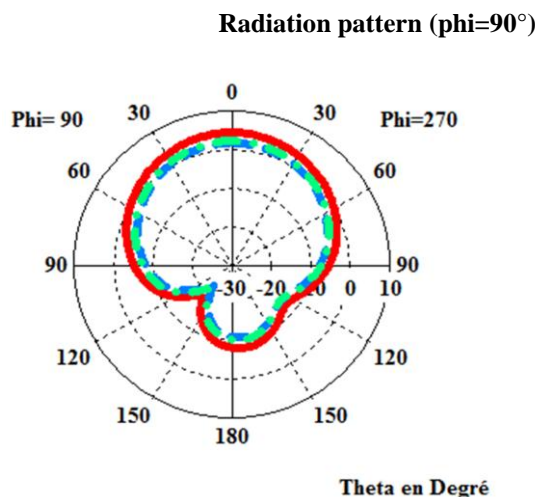

Figure 10: Comparison of the radiation pattern D1 and D2 all OFF in red (*channel 1*), D1 OFF and D2 ON en green (*channel 6*), D1 ON and D2 OFF en blue (*channel 11*)

Table 3: Summary results for different configurations of the frequency reconfigurable patch antenna.

D1	D2	Resonant frequency (GHz)	Coefficient of reflection (dB)	Gain (dB)
OFF	OFF	2.4132	-19.940583	4.42
OFF	ON	2.4372	-16.036429	2.24
ON	OFF	2.4623	-14.924516	1.7

4. Conclusion

Thus, a frequency reconfigurable patch antenna for Wi-Fi applications at 2.4 GHz in order to avoid inter-channel interference is designed. Characteristics such as gain, reflection coefficient and radiation pattern of this antenna were analyzed. This reveals on the one hand that the designed antenna resonated at the center frequencies of channels 1, 6, and 11 of the 2.4 GHz Wi-Fi for different states of the diodes Pin and uniformity of the radiation patterns whatever the state on the Pin diodes on the other hand. The ON states of the Pin diodes degrades the gain.

Finally, it is clear that the design of a frequency reconfigurable patch antenna is a compromise between the level of adaptation, a better frequency tenability of the antenna and the radiation characteristics in terms of gain.

Recommendations: The current trend is converging towards broadband networks. The designers of radiating systems must develop tools to improve the radiation parameters for different ON/OFF states of the diodes of the frequency reconfigurable patch antenna. The introduction of parasitic elements around the radiating structure is possible to increase the gain of the antenna.

References

- [1] Elham Ebrahimi, James R Kelly, and Peter S Hall, "Integrated wide-narrowband antenna for multi-standard radio". *IEEE transactions on antennas and propagation*, 59(7):2628–2635, 2011.
- [2] Katia J. Runser, "Méthodologies pour la planification de réseaux locaux sans-fil" Thèse doctorale l'Institut National des Sciences Appliquées de Lyon, France 2005.
- [3] M. Matinmikko, A. Raivainen, M. Lava-aho, and K. Hiltunen "Interference Study of micro licensing for 5G micro operator small cell Deployment," *Proc. Int. conf. cogn. Radio oriented wirel. Network*, 2017.
- [4] S. J. Orfanidis, *Electromagnetic Waves and antennas*, Rutgers University, 2014.
- [5] C. Wang, B. Yuan, W. Shi and J. Mao, "Low-profile broadband plasma antenna for naval communications in VHF and UHF bands," *IEEE Transactions on Antennas and Propagation*, vol. 68, no. 6, pp. 4271–4282, 2020.
- [6] Kingsly, S.; Thangarasu, D.; Kanagasabai, M.; Alsath, M.G.; Thipparaju, R.R.; Palaniswamy, S.K.; Sambandam, P. Multiband reconfigurable filtering monopole antenna for cognitive radio applications. *IEEE Antennas Wirel. Propag. Lett.* 2018, 17, 1416–1420.
- [7] Jin, G.; Li, M.; Liu, D.; Zeng, G. "A simple planar pattern-reconfigurable antenna based on arc dipoles. *IEEE Antennas Wirel. Propag. Lett.* 2018, 17, 1664–1668.
- [8] Mak, K.M.; Lai, H.W.; Luk, K.M.; Ho, K.L. Polarization reconfigurable circular patch antenna with a C-shaped. *IEEE Trans. Antennas Propag.* 2017, 65, 1388–1392

- [9] S. I. H. Shah and S. Lim, "A dual band frequency reconfigurable origami magic cube antenna for wireless sensor network applications," *Sensors*, vol. 17, no. 11, pp. 2675, 2017.
- [10] I. A. Shah, S. Hayat, I. Khan, I. Aslam, S. Ullah et al., "A compact tri-band and 9-shape reconfigurable antenna for Wi-Fi, WiMAX and WLAN applications," *International Journal of Wireless and Microwave Technologies*, vol. 6, no. 5, pp. 45–53, 2016.
- [11] BEGAUD, X. "Les Antennes Ultra Large Bande", Paris : Lavoisier, Mai 2010.
- [12] Brown, E.R. "RF-MEMS switches for reconfigurable integrated circuits" *IEEE Transactions on Microwave Theory and Techniques*, vol. 46, issue 11, pp. 1868-1880, 1998.
- [13] Abdoulaye Chaibo, A. Ngom, Mahamoud Youssof Khayal, Kharouna Talla, Aboubaker Chedikh Beye "A Novel Bow-Tie Antenna with Triple Band-Notched characteristics for UWB Applications *Journal of Electromagnetic Analysis and Applications*", 2016, 8, 271-282.
- [14] T. S. Rappaport et al., "Millimeter Wave Mobile Communication for 5G Cellular: It Will Work" *IEEE Access*, vol. 1, pp. 335-349, 2013.
- [15] Nadeem, Q.-U.-A.; Kammoun, A.; Debbah, M.; Alouini, M.-S."Design of 5G full dimension massive MIMO systems" *IEEE Trans. Commun.* 2018, 66, 726–74.
- [16] Alka Verma, "Frequency Agility using Gunn diode on a Rectangular Microstrip Antenna," *International Journal on Recent and Innovation Trends in Computing and Communication* ISSN: 2321-8169 Volume: 3 Issue: 8, 2015.
- [17] Purisima, M.C.L.; Salvador, M.; Augstin, S.G.P.; Cunanon, M.T. "Frequency and pattern reconfigurable antennas for community cellular application" In *Proceedings of the IEEE Conference TENCON*, Singapore, 22–25 November 2016.
- [18] Naser Ojaroudi Parchin, Haleh Jahanbakhsh Basherlou, Yasir I. A. Al-Yasir, Raed A. Abd-Alhameed, Ahmed M. Abdulkhaleq, and James M. Noras," *Recent Developments of Reconfigurable Antennas for Current and Future Wireless Communication Systems*," *Electronics* 2019, 8, 128
- [19] C. A. Balanis, *Antenna Theory: Analysis and Design*. Hoboken, New Jersey, United States: John Wiley & Sons, 2016.
- [20] Mehadjji Abri, Fethi Tarik Bendimerad, Nouredine Boukli-Hacene "Transmission line Model for a series fed log-periodic microstrip Antenna array" *IEEE Access*, 6, pp 7350 – 7358, March 2017.
- [21] N. Jin, F. Yangm, and Y. Rahmat-Samii, "A novel patch antenna with switchable slot (PASS): Dual-frequency operation with circular polarizations," *IEEE Trans. Antennas Propag.*, vol. 54, no. 3, Mar. 2006.
- [22] K. L. Finch and N. G. Alexopoulos, "Shunt posts in microstrip transmission lines," *IEEE Trans. Microw. Theory Tech.*, vol. 38, no. 11, pp. 1585–1594, Nov. 1990.
- [23] Yahyra S. H. and Ahmad H. N. Qubain," *Reconfigurable Antenna Design*," *Progress In Electromagnetics Research Symposium Proceedings* 2357, 2015.

- [24] Mohamad Rammal, "Développement d'antennes agiles en fréquence intégrant un condensateur fer roélectrique." Thèse doctorale de l'Université de Limoges, 2017.
- [25] MP42.3-Toshiba American Electronic Components, inc.-Specs, www.datasheet360.com
- [26] Sylvain Loizeau "Conception et Optimisation d'antennes reconfigurables multifonctionnelles et ultra large bande". Thèse doctorale de l'Université Paris Sud, 2009.
- [27] Abdullah Haskou, Ala Sharaiha, Sylvain Collardey. Designing a stacked three-element parasitic superdirective antenna. 17th International Symposium on Antenna Technology and Applied Electromagnetics, Jul 2016, Montréal, Canada
- [28] T. Ikeda, S. Saito, and Y. Kimura, "A dual-band frequency-tunable varactor-loaded single-layer multi-ring microstrip antenna," in *2016 International Symposium on Antennas and Propagation (ISAP)*, 2016, pp. 392–393.
- [29] Erwan Fourn. "Etude et conception de systèmes de communication adaptatifs à base de MEMS aux longueurs d'ondes millimétriques," Thèse doctorale de l'Université de Bretagne Occidentale, 2004